

CFMOTO C FORCE 1000 ATV



BARRE AVANT
FRONT BAR
UCL-C1000-01



BARRE ARRIERE
REAR BAR
UCL-C1000-02

CFMOTO C FORCE 1000 ATV

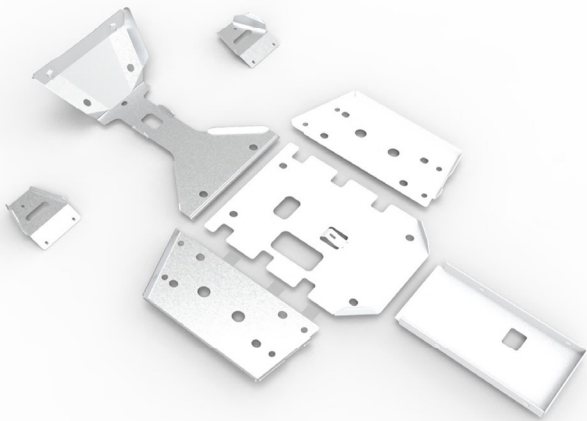

SET PLAQUE DE PROTECTION ALUMINIUM
SKID PLATE FULL SET ALUMINIUM
UCL-1000-07

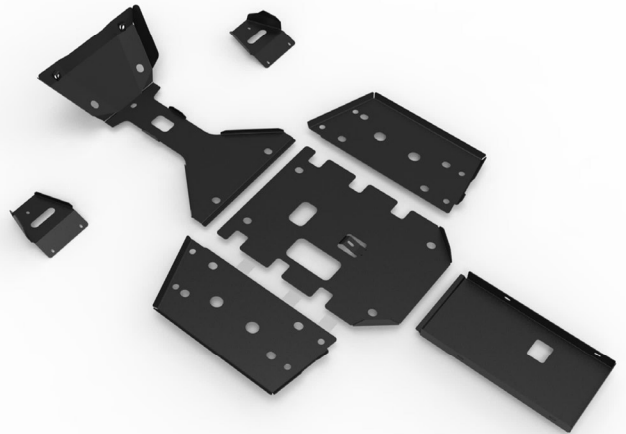

SET PLAQUE DE PROTECTION METAL
SKID PLATE FULL SET METAL
UCL-C1000-08

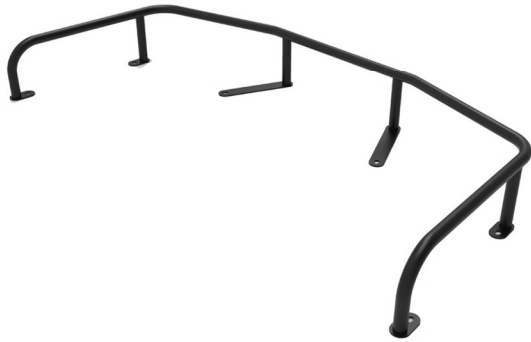

KIT D'EXTENSION DE RACK AVANT
FRONT RACK EXTENDER ASSEMBLY
UCL-C1000-09

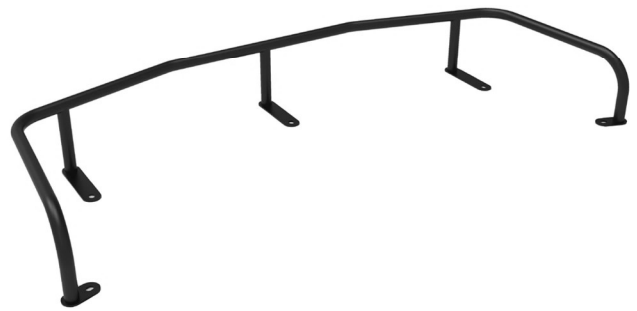

KIT D'EXTENSION DE RACK ARRIERE
REAR RACK EXTENDER ASSEMBLY
UCL-C1000-10



BOUCLIER EN PLEXIGLASS
PLEXI SHIELD
UCL-C1000-03

CFMOTO C FORCE 625 ATV



BARRE AVANT
FRONT BAR
UCL-C625-01



BARRE ARRIERE
REAR BAR
UCL-C625-02

CFMOTO C FORCE 625 ATV

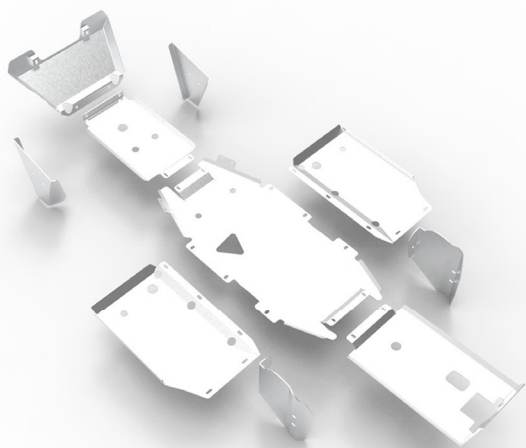

SET PLAQUE DE PROTECTION ALUMINIUM
SKID PLATE FULL SET ALUMINIUM
UCL-C625-07

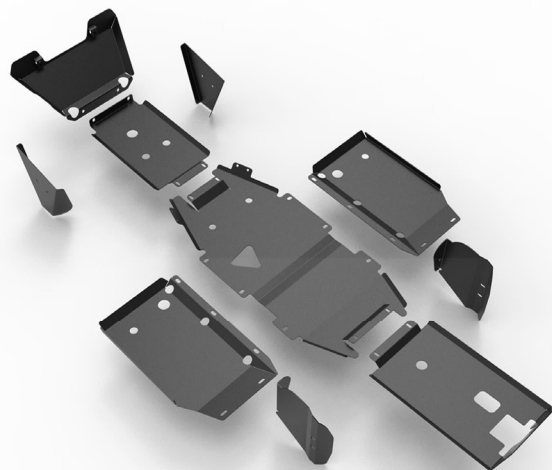

SET PLAQUE DE PROTECTION METAL
SKID PLATE FULL SET METAL
UCL-C625-08



KIT D'EXTENSION DE RACK AVANT
FRONT RACK EXTENDER ASEMBLY
UCL-C625-09



KIT D'EXTENSION DE RACK ARRIERE
REAR RACK EXTENDER ASEMBLY
UCL-C625-010

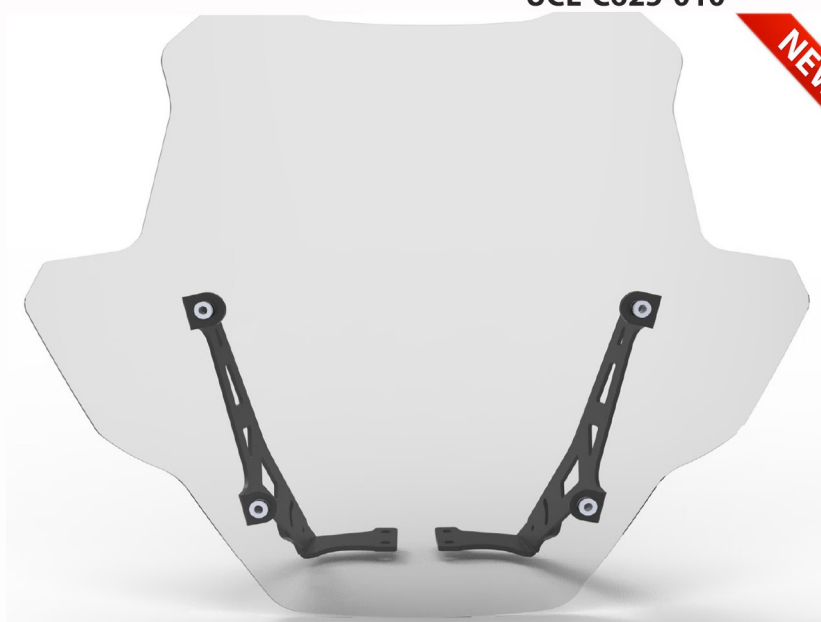

BOUCLIER EN PLEXIGLASS
PLEXI SHIELD
UCL-C625-03



**CFMOTO
C FORCE 450 ATV
(2022-2023)**



**BARRE AVANT
FRONT BAR
UCL-C450-2023-05**



**BARRE ARRIERE
REAR BAR
UCL-C450-2023-06**

CFMOTO

C FORCE 450 ATV (2022-2023)

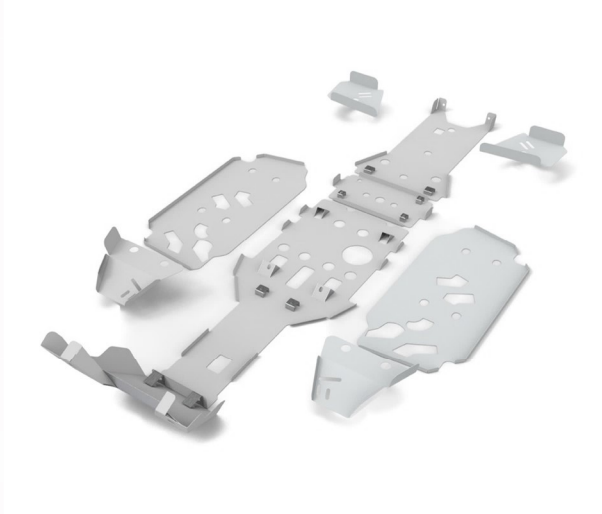

SET PLAQUE DE PROTECTION ALUMINIUM
SKID PLATE FULL SET ALUMINIUM
UCL-C450-2023-03



SET PLAQUE DE PROTECTION METAL
SKID PLATE FULL SET METAL
UCL-C450-2023-04



KIT D'EXTENSION DE RACK AVANT
FRONT RACK EXTENDER ASSEMBLY
UCL-C450-2023-01



KIT D'EXTENSION DE RACK ARRIERE
REAR RACK EXTENDER ASSEMBLY
UCL-C450-2023-02



BOUCLIER EN PLEXIGLASS
PLEXI SHIELD
UCL-C450-2023-07



CFMOTO
Z FORCE 1000 SPORT UTV



BARRE AVANT
FRONT BAR
UCL-Z1000-01



BARRE ARRIERE
REAR BAR
UCL-Z1000-02



BARRE LATÉRALE
SIDE BAR
UCL-Z1000-06

CFMOTO

Z FORCE 1000 SPORT UTV



SET PLAQUE DE PROTECTION ALUMINIUM
SKID PLATE FULL SET ALUMINIUM
UCL-Z1000-07



SET PLAQUE DE PROTECTION METAL
SKID PLATE FULL SET METAL
UCL-Z1000-08



BOUCLIER AVANT EN PLEXIGLASS
FRONT PLEXI SHIELD
UCL-Z1000-13



BOUCLIER ARRIERE EN PLEXIGLASS
REAR PLEXI SHIELD
UCL-Z1000-14



SEGWAY FUGLEMAN UT10 X

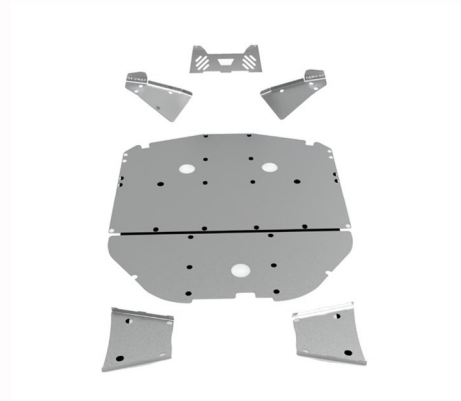

SET PLAQUE DE PROTECTION ALUMINIUM
 SKID PLATE FULL SET ALUMINIUM
UCL-UT10X-01

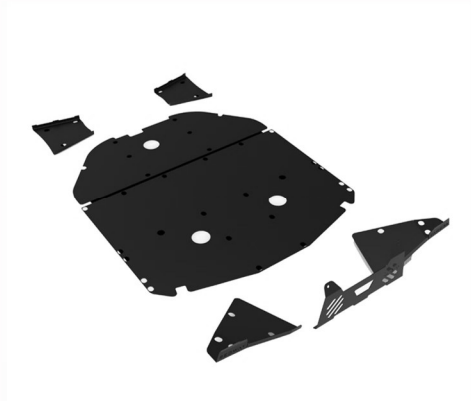

SET PLAQUE DE PROTECTION METAL
 SKID PLATE FULL SET METAL
UCL-UT10X-02

EQUIPEMENT UNIVERSEL POUR QUAD

UNIVERSAL ATV AND UTV EQUIPMENT



ESPACEUR 3 CM
 ATV SPACER 3 CM
UCL-ATVSPR-01



ESPACEUR 3 CM
 UTV SPACER 3 CM
UCL-UTVSPR-02



ESPACEUR 5 CM
 UTV SPACER 5 CM
UCL-UTVSPR-01



ATTELAGE DE REMORQUE
 ATV TOPTOW
UCL-CT-01

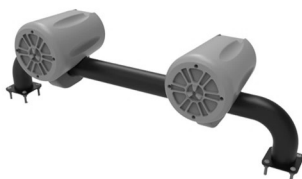

BARRE POUR FIXATION SYSTEME SONORE
UNIVERSEL
 UNIVERSAL SOUND SYSTEM
 FIXING BAR
UCL-CSS-01



POMMEAU DE VITESSE
 GEAR KNOB
UCL-TPZ-01



CFMOTO 250NK (2018-2020)



PROTECTION RADIATEUR
RADIATOR PROTECTION
UCL-NK250-RK-01



PROTECTION ETRIER
CALIPER PROTECTION
UCL-NK250-RK-02



PROTECTION CHAINE
CHAIN PROTECTION
UCL-NK250-RK-04



PROTECTION PHARE
HEADLIGHT PROTECTION
UCL-NK250-RK-05

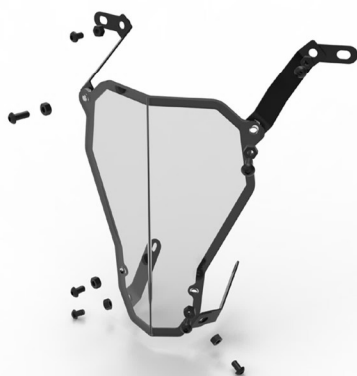

PROTECTION PHARE EN PLEXIGLASS
PLEXI HEADLIGHT PROTECTION
UCL-NK250-RK-09

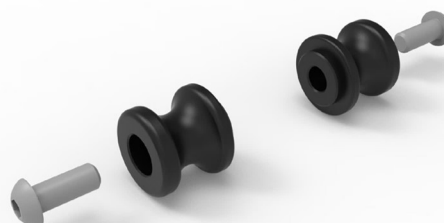

CALE DE LEVAGE
LIFTING WEDGE
UCL-M10-01



CFMOTO 250NK (2023)



PROTECTION RADIATEUR
RADIATOR PROTECTION
UCL-NK250-2023-RK-01



PROTECTION ETRIER
CALIPER PROTECTION
UCL-NK250-KK-02



PROTECTION MOTEUR
ENGINE PROTECTION
UCL-NK250-2023-MK-03



PROTECTION CHAINE
CHAIN PROTECTION
UCL-NK250-ZK-04



PROTECTION PHARE
HEADLIGHT PROTECTION
UCL-NK250-FK-05



GARDE-QUEUE
TAIL PROTECTION
UCL-NK250-2023-KK-06



SUPPORT SAC TOPCASE
TOPCASE BAG IRON
UCL-NK250-2023-TC-07



PROTECTION PHARE EN PLEXIGLASS
PLEXI HEADLIGHT PROTECTION
UCL-NK250-09

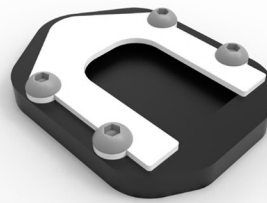

EXTENSION PIED DE BEQUILLE
FOOT EXTENSION
UCL-AG-01



SUPPORT DE LEVAGE
LIFTING WEDGE
UCL-M10-01



CALE DE PROTECTION MOTEUR
ENGINE PROTECTION BRACKET
UCL-NK250-2023-10



CFMOTO 650MT

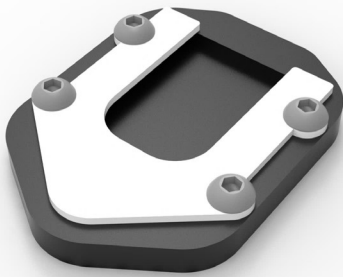

EXTENSION PIED DE BEQUILLE
FOOT EXTENSION
UCL-AG-01



PROTECTION RADIATEUR
RADIATOR PROTECTION
UCL-650MT-02



PROTECTION ETRIER
CALLIPER PROTECTION
UCL-650MT-03

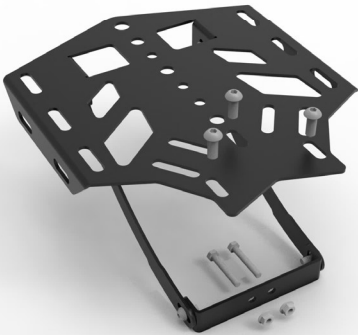

SUPPORT SAC TOPCASE
TOPCASE BAG IRON
UCL-650MT-04

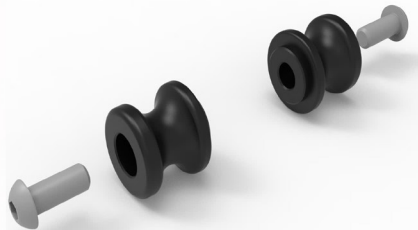

SUPPORT DE LEVAGE
LIFTING WEDGE
UCL-M10-01

MOTO UCEL PROTECTION ECRAN NANO NANO SCREEN GUARD

CFMOTO MOTO / MOTORCYCLE



NK250 - SR250
650MT- 650NK
UCL-NEK-01

CLX250
UCL-NEK-02

450SR
UCL-NEK-03

CLX700 HERITAGE
700 SPORT
UCL-NEK-04

800MT
800MT SPORT
UCL-NEK-05

450NK
UCL-NEK-34

*PAQUET DE 5

CFMOTO QUAD / ATV-UTV



CFORCE 450 L ATV
UCL-NEK-06

CFORCE 625 ATV
Z1000 UTV
U1000 XL UTV
UCL-NEK-07

CFORCE 1000 ATV
UCL-NEK-08

*PAQUET DE 5

POLARIS QUAD / ATV-UTV



RANGER SP570 UTV
SPORTMAN 570 EFI ATV
SPORTMAN XP 1000 ATV
UCL-NEK-32

RZR TRAIL S UTV
RZR XP UTV
UCL-NEK-33

*PAQUET DE 5



CONTACT

SIEGE SOCIAL

37 Avenue Verlaine 27600
Gaillon / France

USINE MOTO ÜCEL

Istanbul / Turquie

AD MOTORZ

+33 6 67 72 60 93

info@admotorz.com

www.admotorz.com

